

In-line seed drills for cereals
MSD

MaterMacc

Speed and homogeneity of distribution



Speed and homogeneity of distribution



MaterMacc pneumatic seed drills are characterised by operating elements with a large excursion and high load, arranged in two rows. The machine, robust and essential, is compact and agile even in headland turns. The high technology package, especially in the electronic field, places it among the most advanced seed drills on the market.

Index

MSD – Speed and homogeneity of distribution

Seed drills for conventional tillage



MSD – Light, simple and precise
Uniform distribution
Technical qualities

6-7

Seed drills for minimum tillage



MSD ELEKTRO – Uniform sowing
Seeding cereals has never been easier
One doser for all types of seed
Efficiency of use
Distribution uniformity

12-13

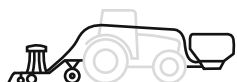

MSD FTC – Productivity guaranteed
The combination of regularity and productivity
Agronomic advantages
Safety at work and during transport
SVA ELEKTRO – Versatility of use
Section exclusion system

18-19

Technical data

22-23

All specifications, dimensions, weights, power, etc. as well as pictures are approximate and not binding. The equipment features shown are not country-specific and may also depict equipment that is not available as standard or not available in all countries. Your local MaterMacc dealer will provide you with all necessary information.

Seed drills for conventional tillage





Light, simple and precise



Pneumatic sowing machine for sowing cereals, forage and rape in rows in tilled ground.

The models in the MSD range are available with working widths from 4 to 6 mt, with hydraulic folding frame. The transport width of the folding frame is equal to 2.55 mt.

In this way, each diffuser supplies a minimum of 100 and a maximum of 150 cm of working width of the machine; for this reason, both versions are particularly prized for the uniformity of seed distribution across the entire working width even when sowing on steep slopes.

MSD allows the rare possibility of adding microgranular products to the seed through an additional tank, external and independent of the main hopper. For example, if you want to apply a treatment or add fertilizer simultaneously. In addition, the same tank can be used for the distribution of minute seeds.

All machines have:

- A large hopper with four dosers for cereals
- A smaller (optional) one for very small seeds or microgranular integrated products;
- A variator gearshift for a perfect calibration.

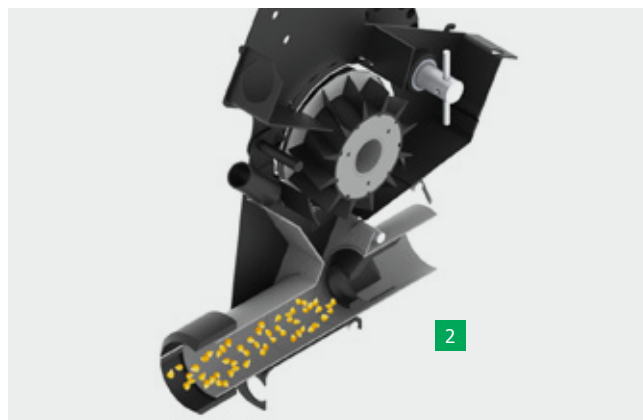

Uniform distribution

The distribution is regulated through an oil bath variator that requires minimal maintenance while maintaining a high and constant level of performance over time. The choice to stay on a variator, instead of an electric transmission, is motivated by the desire to satisfy those customers who rely on concrete and traditional equipment from the simple setting.

Reliability can be monitored with electronic systems that support the operator. The X4 system satisfies the basic checks: it can be used for manual exclusion of sections or for the classic tramlines.

- 1 Distribution head
- 2 Volumetric distributor with Venturi system

Technical qualities



Hydraulic towing device allowing to convert the machine from mounted to towed. Ideal to work on uneven soil and with small tractors. The kit include an independent hydraulic system, with own tank oil reserve, to power the fan for the pneumatical transport of the seeds and, eventually, the microgranular products.



Single disc

The single units are build with the idea to be as simple as possible concerning the cleaning device and the regulation of down-force and depth. As standard are supplied with a mechanical depth limiter hoe.



Single disc (rice type)

The maximum load to the soil can arrived to 25 Kg and for some light soil is suggested a bigger skate to better control the depth of the seed where normally would sink.



Seed covering arrows

It's standard on the machine and is a practical device with a loading spring system and in the lower section there is the possibility to change the angle of work of the special harrow with dovetail shape.



Track eradicators tines

Despite being a very light machine that limits soil compaction, track eradicators are available as an option that can be put in line with the tractor roadway.



Additional tank

This special hopper, always pneumatical, is very important when the farmer wants make distribution lower than 30 Kg or anyway with minute seeds. Or, in the same time, use it to integrate different microgranular products to the seeds from the main tank.



Hydraulic engine for fan

If the tractor does not meet the demand of the PTO (540 rpm) the seeder can be equipped with a motor hydraulically powered by the tractor (40 l/min) that acts directly on the PTO with the correct revolutions.

Seed drills for minimum tillage





Uniform sowing



Seeding cereals has never been easier

MSD Elektro is the pneumatic in-line seed drill for sowing in tilled or semi-tilled soil for cereals, forage crops and rapeseed. Working widths of 5 and 6 metres offer a minimum row spacing of 12.5 cm.

A great combination of one of the industry's best minimum

tillage seeding bars and a compact hopper design that allows excellent working visibility. The hopper has a standard loading volume of 1300 litres. The real heart of the machine is the distribution with 4 metering units and 4 distribution heads that optimise seeding homogeneity.



One doser for all types of seed

The metering system ensures optimum performance and consistency of distribution.

The variable cell spools of the MagicDrill seeding distributor can be used individually, when seeding small seeds, or operated simultaneously to obtain doses of up to 450 kg/ha. Selecting the most appropriate spool is easily done manually.

The 4 distributors can be fully inspected to optimise and minimise cleaning operations.

The sowing test is also easy to perform thanks to the free space between the distributors.

- 1 No spools to change from one crop to another
- 2 All settings are external to the metering unit, easy to access and quick to set
- 3 Wide range of dispensable quantities (kg); can also be used for fertilizer distribution (not at the same time as seed).

Efficiency of use, for different soil types

- 1 Articulated parallelogram to follow ground contours
- 2 Adjustable load spring up to 45 kg
- 3 Single or double disc coulters Ø 360 mm
- 4 Seed press wheel and depth control Ø 250 mm
- 5 Seed cover spring on wheel

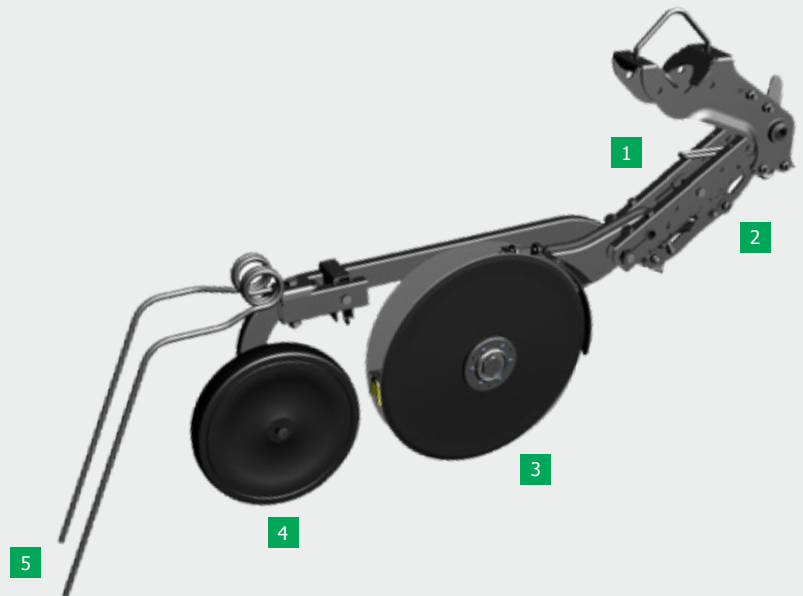

Robustness and reliability thanks to the special disc furrow opener with wheel

The articulated parallelogram of the seeding unit provides greater robustness and reliability over time, even under minimum tillage conditions at high seeding speeds. The seeding wheel can be adjusted manually and acts as a seeding depth limiter.



Single disc coulters with depth limiter

The structure of the single disc is designed to better absorb shocks as it is made with bending and bolted, with very few welding points. The ground load is per element with a ratchet device.



Single disc with wheel for depth control

The single disc has several scrapers for automatic cleaning of the same. This also makes it ideal for sticky soils. The wheel helps to maintain the correct depth in all conditions.

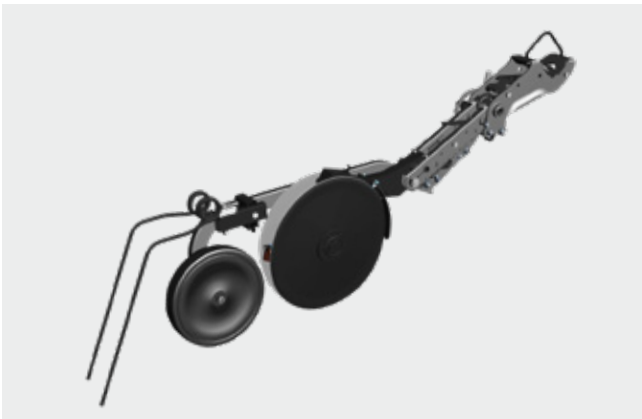

Double disc with wheel for depth control

The double disc is recommended for heavier soils and better absorbs combined loads, therefore also lateral, relying on a double bearing apparatus.



Cover harrow with S-shaped spring

Based on our long experience in the field, a seed cover has been chosen that can stand out skilled on any soil texture and even in the presence of crop residues without degenerate on the dragging effect of the same.



Seed cover spring on wheel

For the version with depth wheel, the choice of the covering harrow went on a straight tooth spring, more effective in this context since the wheel already performs a press-seed and covering action.



Element pressure loading system

A spring driven by the ratchet system can generate a modular load of up to 45 kg. Everything is caged in a sturdy structure at bent and bolted without welding.

Distribution uniformity



What sets MSD ELEKTRO apart is the system with four distribution heads that ensure optimal uniformity. The special configuration characterized by the low heads close to the elements ensures instantaneous seeding and less risk of clogging due to shorter circuits.

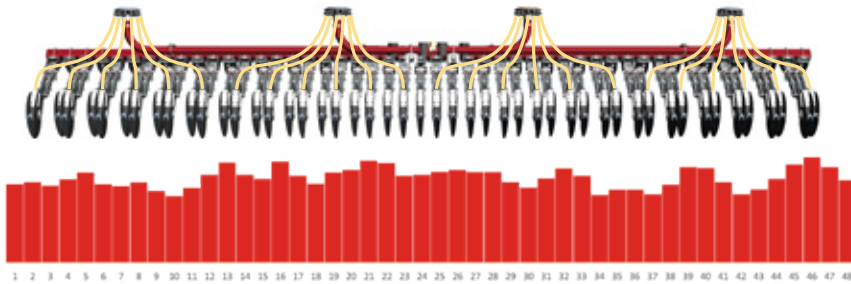

MSD ELEKTRO seed drill from MaterMacc, with four distribution heads: proof of homogeneity on single row

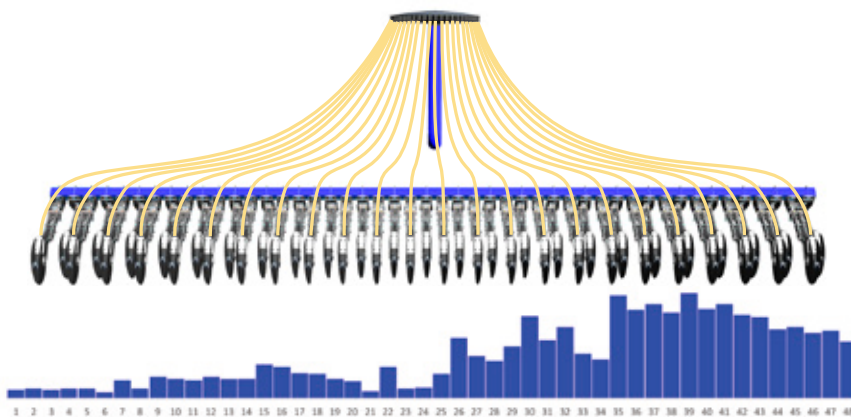

Classic seed drill with single distribution head

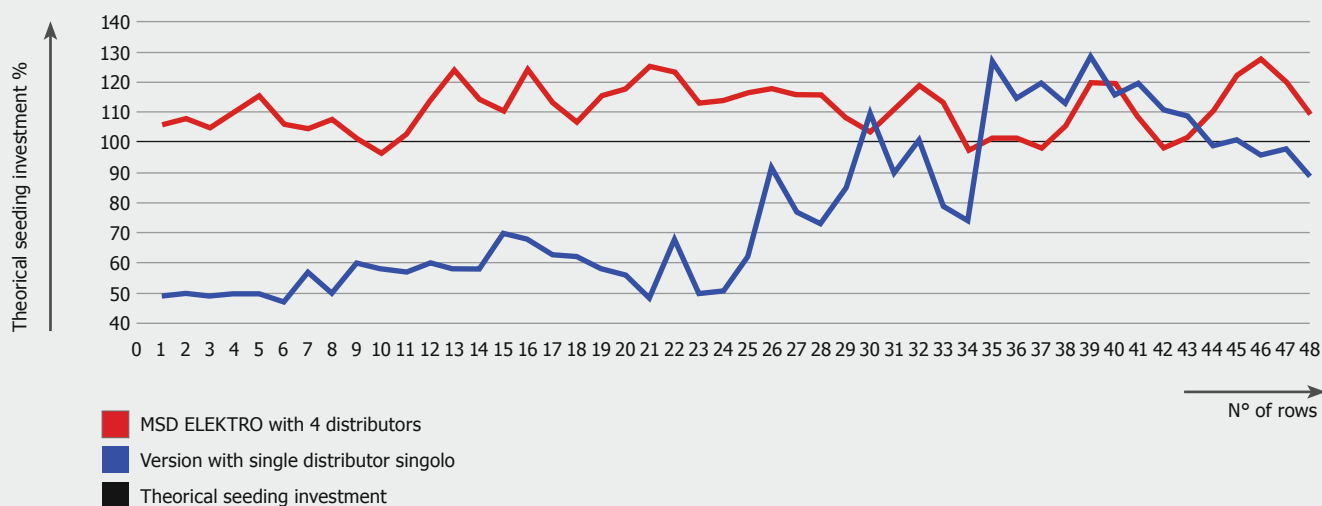

Seed distribution is perfectly distributed by the 4 seed distributors and as many mixing heads (average error of 6 % compared with that of 26 % for the compared single distribution head machines). This excellent solution minimises metering error across the entire working width. In addition, the 4 seeding sections can be individually excluded in the event of overlaps. Test run: rape, 5 kg/ha at a speed of 12 km/h.



Electric dosing

The electric drive makes it possible to automate their calibration before sowing begins with advantage to vary the dose during work. It can independently manage PRESTART to allows the entire surface of the field, including the borders, to be sown perfectly.

X4 monitor functions

- Seeding control alarm
- Working speed
- Turbine RPM sensor
- Seed level sensor
- Predisposition for tramlines
- Provision for section exclusion

Productivity guaranteed



The combination of regularity and productivity

MSD FTC retains the outstanding seeding qualities of MSD ELEKTRO with the addition of the high capacity of the hopper which, placed at the front of the tractor, acts as a balancer by distributing the weight of the seed drill evenly over the four wheels of the tractor, limiting the effect of compaction.

The front hopper is the multi-purpose SVA Elektro, offered for seed distribution. The capacity is 1800 litres. As standard it is supplied with a tractor-dependent hydraulic fan, but it is also possible to choose the mechanically activated version if your tractor does not meet the required criteria (approx. 40 litres/min required).

With the high hopper capacity, it is possible to sow over 10 hectares before having to refill the hopper. It is also possible to use the SVA Elektro in combination with weeders or precision planters, using it for the distribution of granular fertiliser.

Thanks to the performance of the sturdy element and the new metering unit, seeding speed on prepared soil is up to 15 km/h! This translates into an hourly productivity of more than 6 hectares/hour.



Agronomic advantages

- Allow even shallow sowing thanks to reduced compaction; localise the seed where the best moisture content is maintained.
- Differentiate inter-rows with simple devices (e.g. distribution head plugs) and thus manage crop rotations in order to keep the soil fertile.

Safety at work and during transport

The two-section frame construction ensures easy opening and closing as well as visibility and safety during transport. Thanks to the greater ground clearance, the support wheels are spaced out for a more stable set-up using a wide wheel tread.

The front hopper is equipped with an inspection platform and powerful LED lights, as well as parking wheels when disconnecting from the tractor.

High tank capacity



When you can do it all with one hopper

A front hopper that can be used indifferently for distributing seed or fertiliser without replacing any of the components that make up the dosers. They can be 2 or 4 in number with their respective tubes that are attached to the side of the tractor cab to transport the product to the rear implement. The latter can be a weeder, a cultivator, a planter, which can be equipped with two or four dispensing heads.

SVA ELEKTRO can be implemented on any implement, even on its own fleet, as it is independent both functionally and system-wise. It can be elevated with Isobus protocol and the interface will be displayed on the virtual terminal as a separate machine. The choice between 2 or 4 distributors must be motivated not only by the type of equipment you have, but also by the distribution volume you wish to achieve.

The SVA ELEKTRO with 4 dosing units, for example, can distribute up to 600 kg/ha of fertiliser or more, in proportion to the working width and forward speed.

The versatility of the combinations is not limited to the two examples in the figure but also extends to combinations with rotary or passive harrows or equipment from one's own fleet.



Excluding sections system

MSD FTC consists of an electric seed distribution system controlled by an X4 control unit that monitors and records work data. Upgrading to an Isobus system is possible. In addition, all machines are equipped with electronic scales for seed testing.

Distribution can also be managed while seeding by varying the application rate in percentages. With the exclusions accessory, the sections made up of the four dispensers provided can be partialized. The presence of the four distribution heads simplifies dose management for the active sections by ensuring the right proportions in terms of quantity/hectare.

Exclusion is also indicated to avoid overlapping where you have already sown and complete the field by optimizing the use of seed while always maintaining the right proportions.

Ease to use

It is possible to manage exclusion with a simple 'tap' on the screen or, if Isobus, enter or trace a perimeter map and execute it automatically.

Seeding control system based on ISOBUS standard (ISO 11783). Compatible with tractor/monitor with ISOBUS technology.

- Distribution control alarm
- Partial and total hectare counters
- Working speed
- Blower rpm sensor
- Product level sensor
- PreStart, PreStop distribution
- Predisposition for tramlines
- Provision for section exclusion

Technical data

MSD	Row spacing	Work width	Weight single disc	Power request
400 32 ROWS	12,5 cm	254-400 cm	1160 kg	80 hp
500 32 ROWS	15,6 cm	254-500 cm	1230 kg	80 hp
500 40 ROWS	12,5 cm	254-500 cm	1315 kg	100 hp
600 40 ROWS	15 cm	254-600 cm	1410 kg	100 hp
600 48 ROWS	12,5 cm	254-600 cm	1490 kg	110 hp

MSD ELEKTRO	Row spacing	Work width	Weight single disc	Weight single disc and wheel
500 32 ROWS	15 cm	270-500 cm	1440 kg	1630 kg
500 40 ROWS	12,5-15 cm	270-500 cm	1550 kg	1790 kg
600 40 ROWS	15 cm	270-500 cm	1560 kg	1800 kg
600 48 ROWS	12,5 cm	270-500 cm	1670 kg	1960 kg

MSD FTC	Row spacing	Work width	Weight single disc	Weight single disc and wheel
500 32 ROWS	15 cm	270-500 cm	1640 kg	1830 kg
500 40 ROWS	12,5 cm	270-500 cm	1750 kg	1990 kg
600 40 ROWS	15 cm	270-600 cm	1760 kg	2000 kg
600 48 ROWS	12,5 cm	270-600 cm	1870 kg	2160 kg

SVA ELEKTRO	Dimensions (length / width / depth)	Dry weight	Power request	Capacity
2 DISTRIBUTORS	230x160x135 cm	450 kg	100 hp	1800 l.
4 DISTRIBUTORS	230x160x135 cm	480 kg	100 hp	1800 l.

Ferti capacity

1000 l.

1000 l.

1000 l.

1000 l.

1000 l.

Weight double disc and wheel	Power request	Seed capacity
---	----------------------	----------------------

1690 kg	100 hp	1300 l.
---------	--------	---------

1880 kg	120 hp	1300 l.
---------	--------	---------

1920 kg	120 hp	1300 l.
---------	--------	---------

2110 kg	130 hp	1300 l.
---------	--------	---------

Weight double disc and wheel	Power request	Seed capacity
---	----------------------	----------------------

1890 kg	90 hp	1800 l.
---------	-------	---------

2080 kg	110 hp	1800 l.
---------	--------	---------

2120 kg	110 hp	1800 l.
---------	--------	---------

2310 kg	120 hp	1800 l.
---------	--------	---------



Our company history

- MaterMacc was founded in 1983 out of a passion for agriculture and the constant search for new solutions in agriculture.
- The company specialises in the development and manufacture of pneumatic precision planters for traditional crops as well as pneumatic and mechanical planters, no-till planters and crop care machines.
- We also manufacture electronic equipment for the control and management of agricultural machinery and tools for controlling irrigation systems.
- MaterMacc stands for technology and quality – made in Italy to serve agriculture.

Quality in cereals sowing

- Precision also in cereal seeding with MaterMacc. Robust and stable seed drills with a perfect balance of the sections thanks to the large tread support wheels and well spaced apart from the total working width
- The operating elements are characterized by a large excursion and a high load. The absence of welding on the elements prevents breakage for a better durability over time
- We believe that the performance of our products and services means above all offering the customer the economic growth of his company over time, because his success is our success
- MaterMacc, Smart precision planters

Company contact details:

MaterMacc S.r.l.

Registered office:
Via Leonardo da Vinci 2/c
39100 Bolzano BZ
ITALY

Headquarters:
Via Gemona, 18
33078 San Vito al Tagliamento (PN)
ITALY
Tel. + 39 0434 85267
info@matermacc.it
www.matermacc.it